

Placas I 40 (430x280)

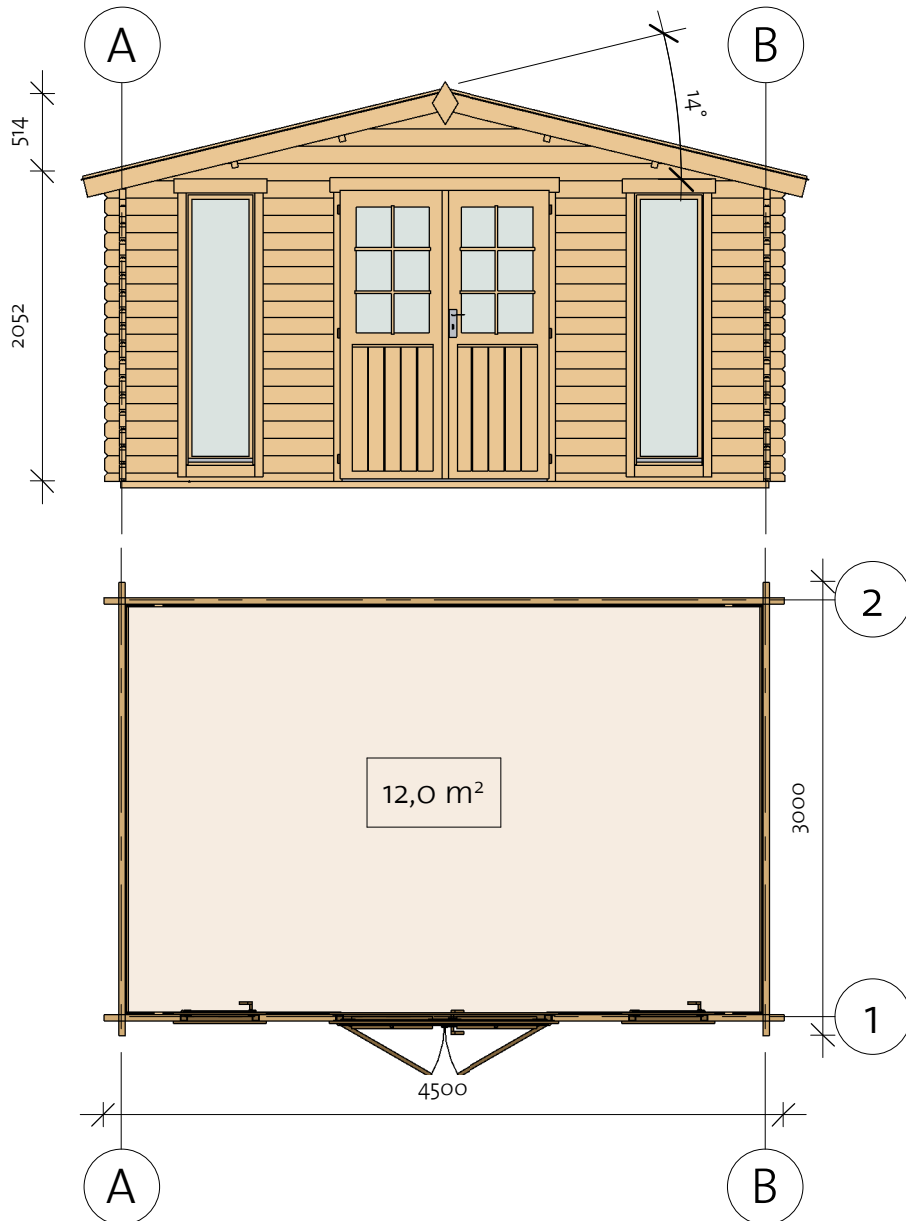

Placas I 40 (430x280)

Foundation

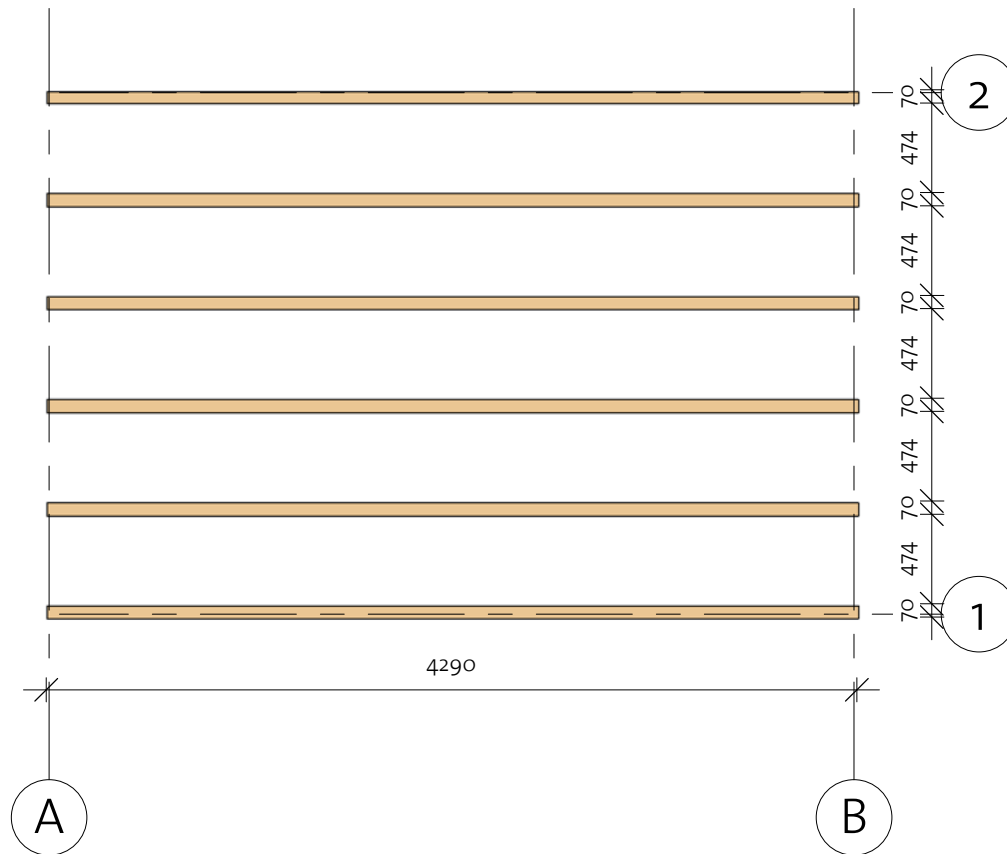

| Impregnated foundation beams | | | | |
|------------------------------|------|---------|-------|--------|
| Mark | Type | Profile | Count | Length |

| | | | | |
|-----|--------------|---|---|------|
| IFB | IFB 70x40 |  | 6 | 4290 |
|-----|--------------|---|---|------|

Placas I 40 (430x280)

Floor Plan

1 Baseboard

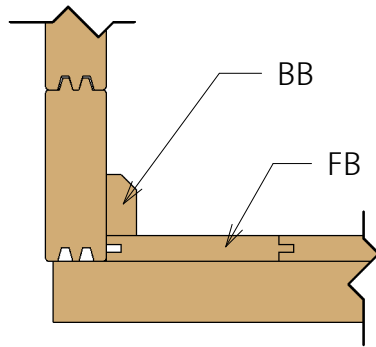

Floor Schedule

| Mark | Type | Profile | Count | Length |
|------|-----------|---------|-------|--------|
| FB | FB 17x114 | | 38 | 2717 |
| BB1 | BB 20x40 | | 2 | 4300 |
| BB2 | BB 20x40 | | 2 | 2800 |

200403

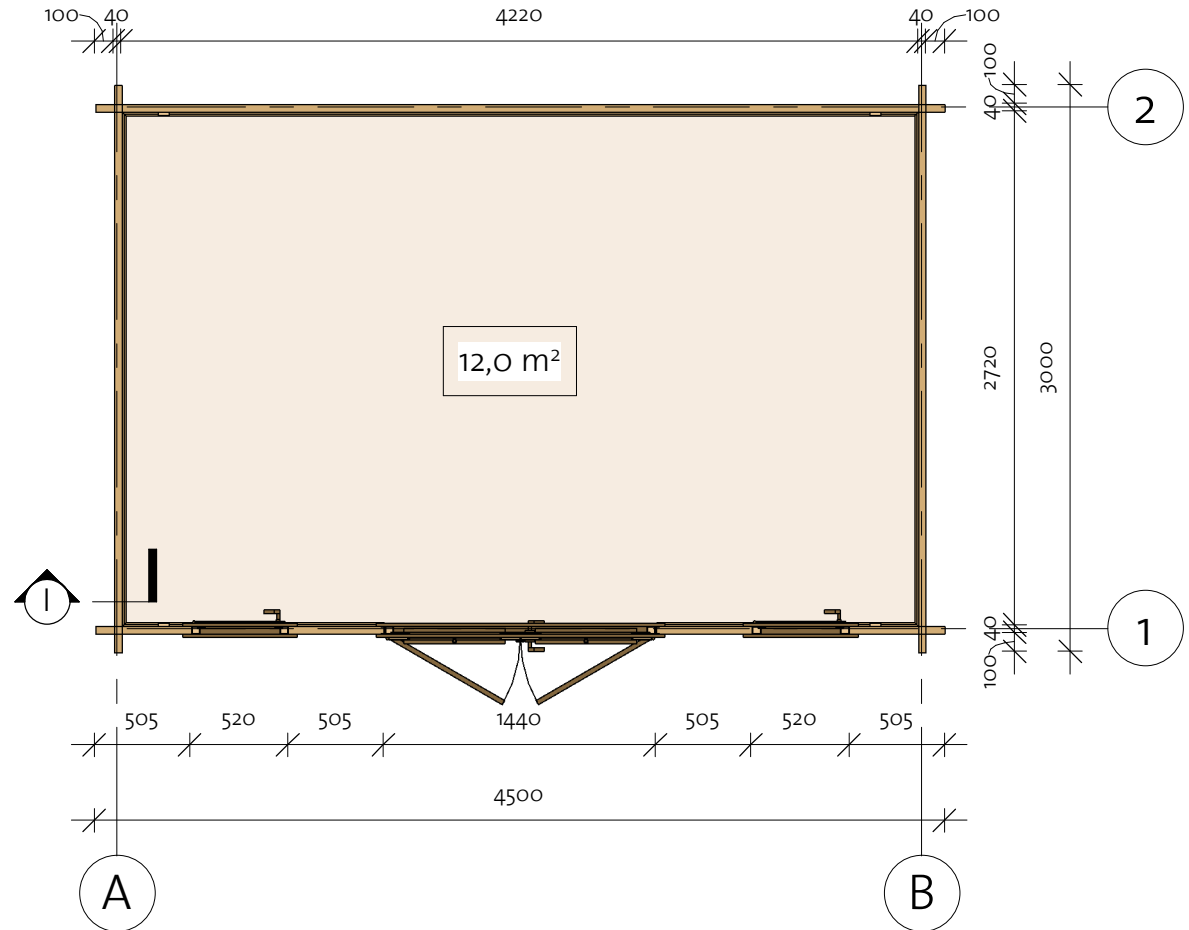

Placas I 40 (430x280)

Wall 1





| Wall 1 | | | |
|--------|---------|-------|------------|
| Mark | Profile | Count | Cut Length |

| | | | |
|--------|--------|----|------|
| 1BL-1 | 40x57 | 2 | 1530 |
| 1LG-1* | 40x114 | 1 | 941 |
| 1LG-2* | 40x114 | 1 | 1878 |
| 1LG-3* | 40x114 | 1 | 2801 |
| 1LG-4* | 40x114 | 1 | 3752 |
| 1LG-5 | 40x114 | 34 | 505 |
| 1LG-6* | 40x114 | 1 | 4500 |
| 1LG-7 | 40x114 | 34 | 505 |

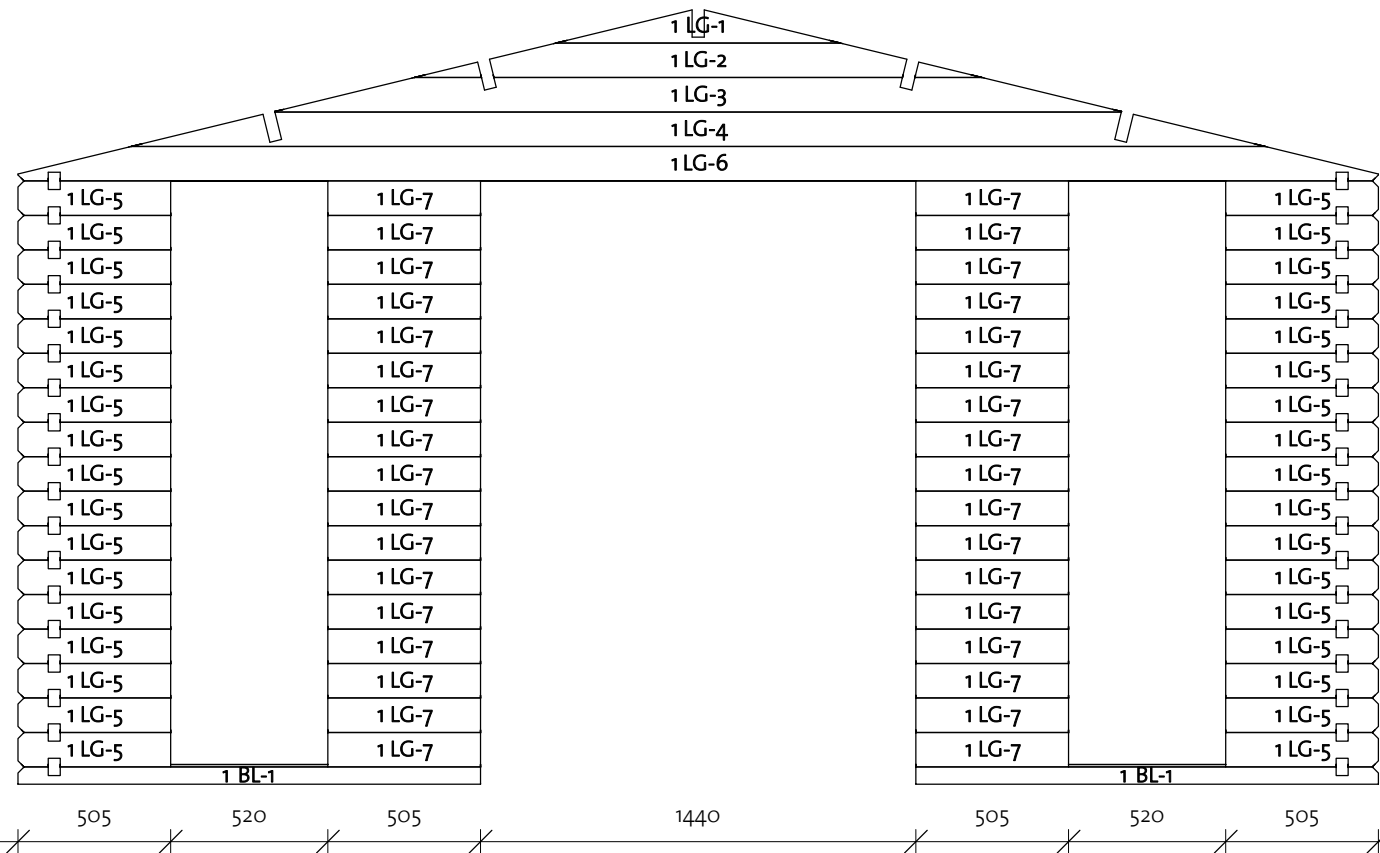
*Gable-delivered premounted



| Log Profile Wall 1 | |
|--------------------|---------|
| Profile | Profile |

| | |
|--------|---|
| 40x57 |  |
| 40x114 |  |

Placas I 40 (430x280)

Wall A

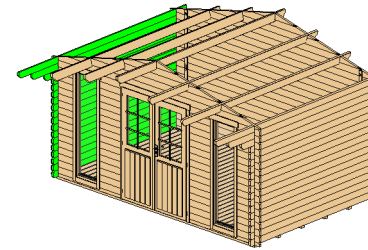

| Wall A | | | |
|--------|---------|-------|------------|
| Mark | Profile | Count | Cut Length |

| | | | |
|-------|--------|----|------|
| ALG-1 | 40x114 | 15 | 3000 |
| ALG-2 | 40x114 | 1 | 3200 |
| ALG-3 | 40x114 | 1 | 3500 |
| ATL-1 | 40x114 | 1 | 3900 |

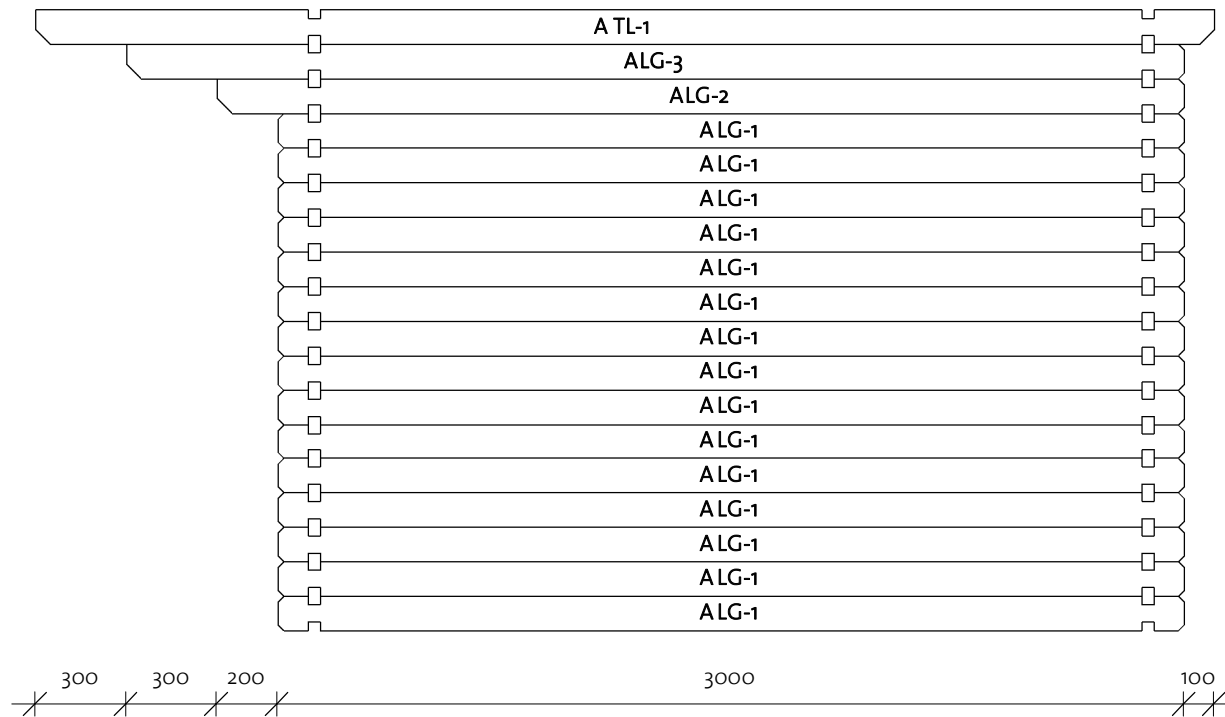

| Log Profile Wall A | |
|--------------------|---------|
| Profile | Profile |

| | |
|--------|--|
| 40x114 | |
| 40x114 | |

Placas I 40 (430x280)

Wall B

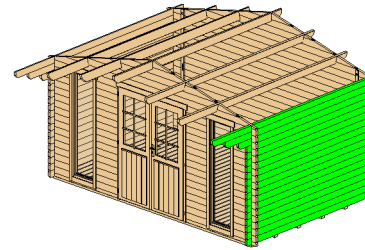

| Wall B | | | |
|--------|---------|-------|------------|
| Mark | Profile | Count | Cut Length |

| | | | |
|-------|--------|----|------|
| BLG-1 | 40x114 | 15 | 3000 |
| BLG-2 | 40x114 | 1 | 3200 |
| BLG-3 | 40x114 | 1 | 3500 |
| BTL-1 | 40x114 | 1 | 3900 |

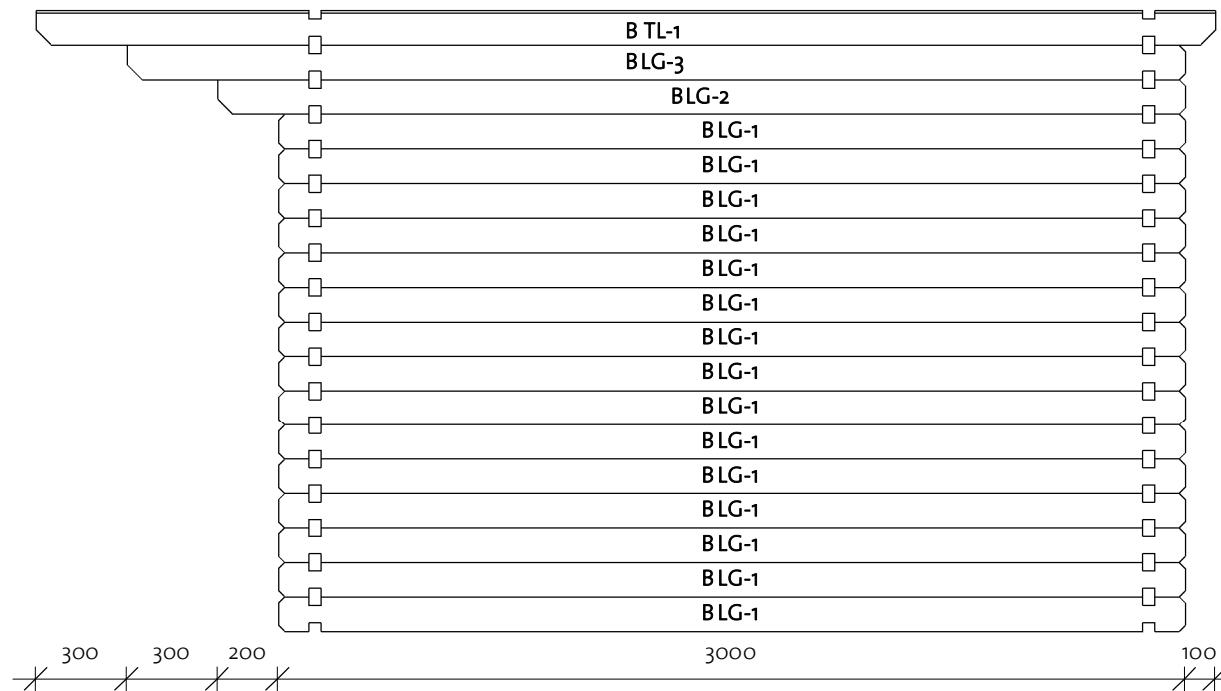



| Log Profile Wall B | |
|--------------------|---------|
| Profile | Profile |

| | |
|--------|--|
| 40x114 | |
| 40x114 | |

Placas I 40 (430x280)

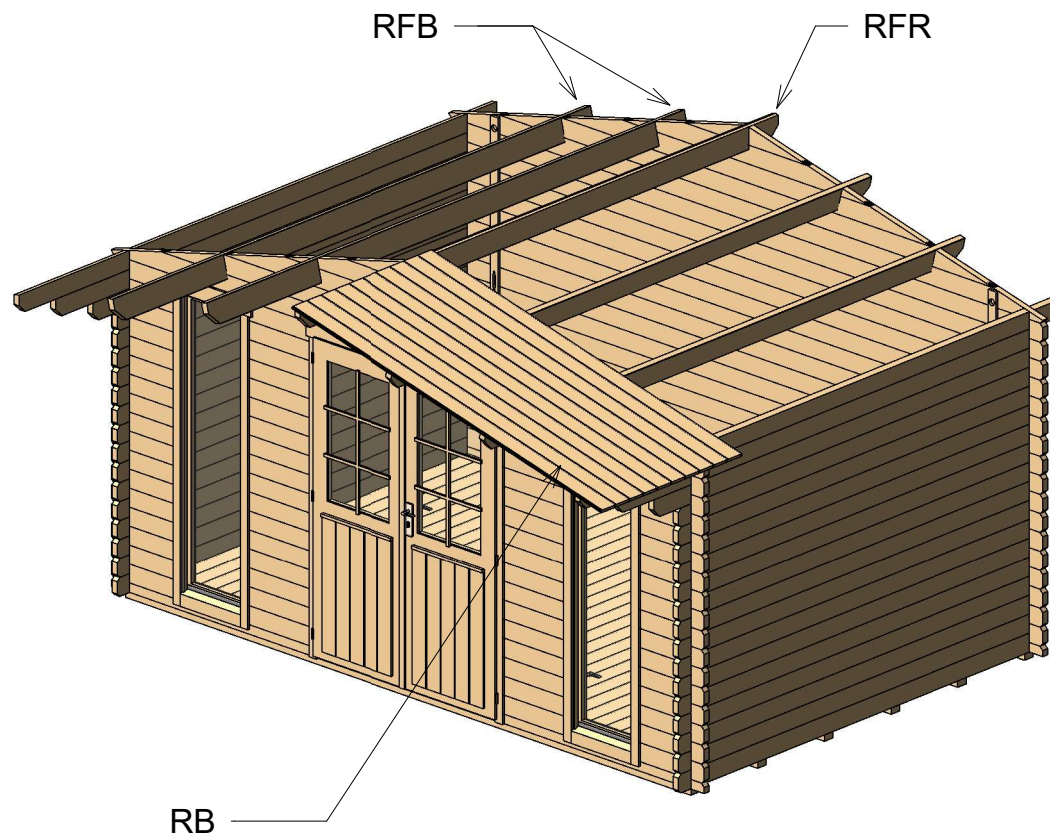
Roof 1

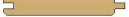

| Roof | | | | |
|------|-----------------|---|-------|--------|
| Mark | Type | Profile | Count | Length |
| RFR | Ridge 40x143 |  | 1 | 3900 |
| RFB | Beam 40x143 |  | 4 | 3900 |
| RB | 17x114 |  | 72 | 2420 |

Placas I 40 (430x280)

Roof 2

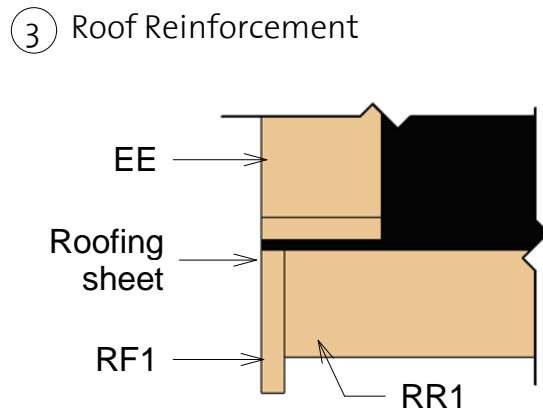
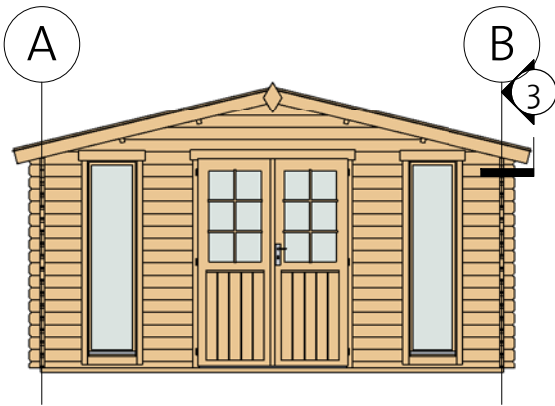
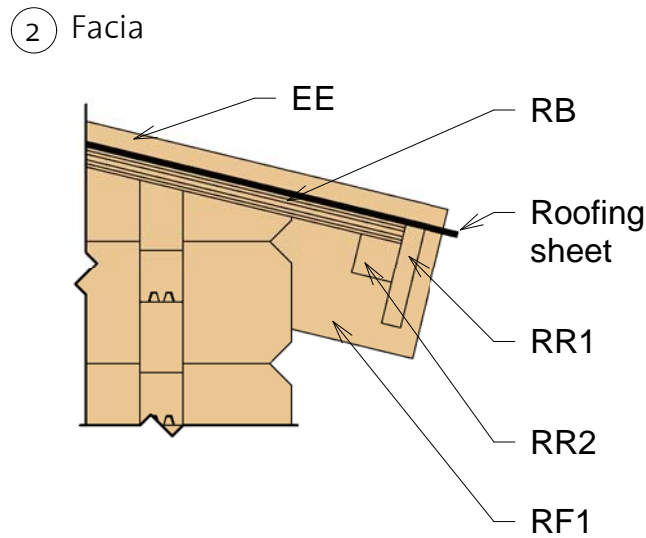
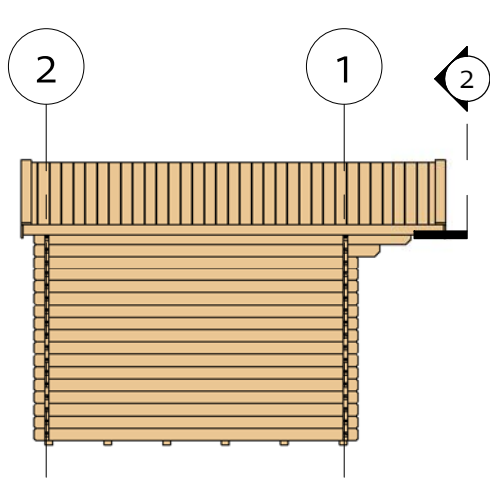

| Fascia Schedule | | | | |
|-----------------|--------------------------------|---------|-------|--------|
| Mark | Type | Profile | Count | Length |
| EE | Eave Edging 18x95 | | 4 | 2460 |
| RF1 | Roof Fascia 18x120 | | 4 | 2460 |
| RR1 | Roof reinforcement 18x95 | | 2 | 3900 |
| RR2 | Roof reinforcement 38x38 | | 2 | 3900 |

Placas I 40 (430x280)

Extras

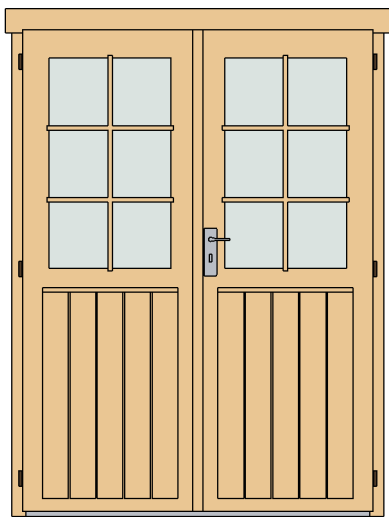

| Door Schedule | | | | |
|---------------|--------------------------------|-------|--------|-------|
| Mark | Type | Width | Height | Count |
| CDD1R | Classic double door 1 right | 1425 | 1955 | 1 |
| DCB6 | Door Crossbar 6 | -- | -- | 2 |

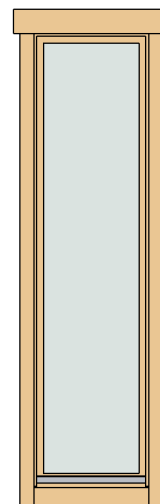

| Window Schedule | | | | |
|-----------------|--------------------------------|-------|--------|-------|
| Mark | Type | Width | Height | Count |
| CW21R | Classic window 21 right | 515 | 1890 | 2 |
| WCB8 | Windows Crossbar 8 optional | -- | -- | 2 |

| Monitor - Fasteners/Extras | | |
|----------------------------|------|-------|
| Name | Type | Count |

| | | |
|----------|------------|-----|
| Hitblock | 300-400 mm | |
| Screws | 5,0 x 70 | 10 |
| Bolts | M8 x 70 | 12 |
| Screws | 6,0x140 | 35 |
| Nails | 1,4 x 40 | 40 |
| Screws | 4,0 x 40 | 640 |

| Family | Count |
|--------|-------|
|--------|-------|

| | |
|------|---|
| Romb | 2 |
|------|---|



- * Windows intended for tilt opening only!
- * Fenster zur Eröffnung nur zum Kippen vorgesehen!
- * Aknad on ette nähtud ainult kaldu avamiseks!



| Type | Count | Length |
|------|-------|--------|
|------|-------|--------|

| | | |
|--------------------|---|------|
| Windboard 18x40 | 4 | 2200 |
|--------------------|---|------|



Placas I 40 (430x280)

List of all items 1



Impregnated foundation beams

| Mark | Type | Profile | Count | Length |
|------|--------------|---|-------|--------|
| IFB | IFB 70x40 |  | 6 | 4290 |





Floor Schedule

| Mark | Type | Profile | Count | Length |
|------|-------------|---|-------|--------|
| FB | FB 17x114 |  | 38 | 2717 |
| BB | BB 20x40 |  | 2 | 4300 |
| BB | BB 20x40 | | 2 | 2800 |

Roof

| Mark | Type | Profile | Count | Length |
|------|-----------------|---|-------|--------|
| RFR | Ridge 40x143 |  | 1 | 3900 |
| RFB | Beam 40x143 |  | 4 | 3900 |
| RB | 17x114 |  | 72 | 2420 |

Fascia Schedule

| Mark | Type | Profile | Count | Length |
|------|--------------------------------|---|-------|--------|
| EE | Eave Edging 18x95 |  | 4 | 2460 |
| RF1 | Roof Fascia 18x120 |  | 4 | 2460 |
| RR1 | Roof reinforcement 18x95 |  | 2 | 3900 |
| RR2 | Roof reinforcement 38x38 |  | 2 | 3900 |

Placas I 40 (430x280)

List of all items 2

| Wall 1 | | | |
|--------|---------|-------|------------|
| Mark | Profile | Count | Cut Length |

| | | | |
|---------|--------|----|------|
| 1BL-1 | 40x57 | 2 | 1530 |
| 1LG-1 * | 40x114 | 1 | 941 |
| 1LG-2 * | 40x114 | 1 | 1878 |
| 1LG-3 * | 40x114 | 1 | 2801 |
| 1LG-4 * | 40x114 | 1 | 3752 |
| 1LG-5 | 40x114 | 34 | 505 |
| 1LG-6 * | 40x114 | 1 | 4500 |
| 1LG-7 | 40x114 | 34 | 505 |

| Wall 2 | | | |
|--------|---------|-------|------------|
| Mark | Profile | Count | Cut Length |

| | | | |
|---------|--------|----|------|
| 2BL-1 | 40x57 | 1 | 4500 |
| 2LG-1 * | 40x114 | 1 | 941 |
| 2LG-2 * | 40x114 | 1 | 1878 |
| 2LG-3 * | 40x114 | 1 | 2801 |
| 2LG-4 * | 40x114 | 1 | 3752 |
| 2LG-5 * | 40x114 | 1 | 4500 |
| 2LG-6 | 40x114 | 17 | 4500 |

*Gable-delivered premounted

| Wall A | | | |
|--------|---------|-------|------------|
| Mark | Profile | Count | Cut Length |



| | | | |
|-------|--------|----|------|
| ALG-1 | 40x114 | 15 | 3000 |
| ALG-2 | 40x114 | 1 | 3200 |
| ALG-3 | 40x114 | 1 | 3500 |
| ATL-1 | 40x114 | 1 | 3900 |

| Wall B | | | |
|--------|---------|-------|------------|
| Mark | Profile | Count | Cut Length |

| | | | |
|-------|--------|----|------|
| BLG-1 | 40x114 | 15 | 3000 |
| BLG-2 | 40x114 | 1 | 3200 |
| BLG-3 | 40x114 | 1 | 3500 |
| BTL-1 | 40x114 | 1 | 3900 |

* Gable - delivered premounted

| Log Profiles | |
|--------------|---------|
| Profile | Profile |

| | |
|--------|---|
| 40x57 |  |
| 40x114 |  |

| Log Profiles | |
|--------------|---------|
| Profile | Profile |

| | |
|--------|---|
| 40x114 |  |
|--------|---|

Windboard

① Windboard Assembly 1



② Windboard Assembly 2

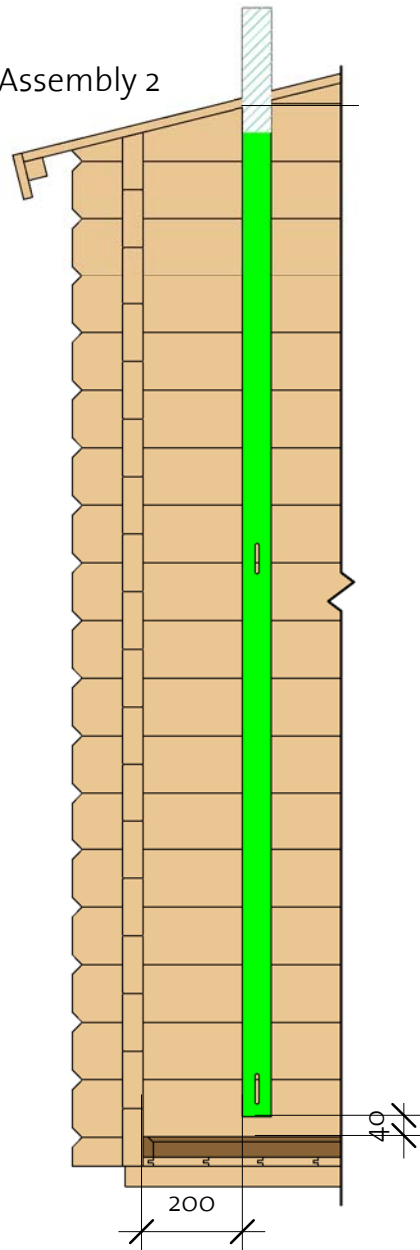

③ Windboard Assembly 3

